



AraMIMO: Programmable TVWS mMIMO Living Lab for Rural Wireless

Taimoor Ul Islam, Tianyi Zhang, Joshua Ofori Boateng, Evan Gossling, Guoying Zu, Sarath Babu, Hongwei Zhang, Daji Qiao

Department of Electrical and Computer Engineering, Iowa State University, U.S.A.
{tislam, tianyiz, jboateng, evang, gyzu, sarath4, hongwei, daji}@iastate.edu

ABSTRACT

Rural broadband is critical to industries and community services such as precision agriculture, renewable energy, and rural education. Yet 39% of rural US and over 4 billion people around the world still lack broadband access. Addressing the challenge requires rural-focused technology research and innovation that provide high-capacity, long-range connectivity to sparsely populated areas at an affordable cost. To this end, we design, implement, and deploy *AraMIMO*, the first-of-its-kind TV White Space (TVWS) many-antenna MIMO (mMIMO) living lab for rural wireless research, education, and innovation. As a key part of the ARA PAWR infrastructure, AraMIMO features the field-deployed multi-user MIMO (MU-MIMO) system, Skylark Faros V2, exploiting the TVWS spectrum to provide high-capacity connectivity over large geographical areas of radius up to 10 km. With rich APIs to monitor and control the behavior of production-grade mMIMO systems, AraMIMO integrates programmability with high performance, and, with its user-friendly experimentation workflow and remote access support, AraMIMO serves as an invaluable living lab for rural wireless and applications. Measurement studies have demonstrated great promise, for instance, having achieved a single-sector spectral efficiency of 16 b/s/Hz with a 6 MHz TVWS channel and 6 clients in real-world rural settings. AraMIMO also enables interesting wireless experiments such as characterizing the impact of multi-user beamforming on network capacity, as well as application experiments such as agriculture automation.

Permission to make digital or hard copies of all or part of this work for personal or classroom use is granted without fee provided that copies are not made or distributed for profit or commercial advantage and that copies bear this notice and the full citation on the first page. Copyrights for components of this work owned by others than the author(s) must be honored. Abstracting with credit is permitted. To copy otherwise, or republish, to post on servers or to redistribute to lists, requires prior specific permission and/or a fee. Request permissions from permissions@acm.org.
ACM WiNTECH' 23, October 6, 2023, Madrid, Spain
© 2023 Copyright held by the owner/author(s). Publication rights licensed to ACM.

ACM ISBN 979-8-4007-0340-9/23/10.

<https://doi.org/10.1145/3615453.3616512>

KEYWORDS

AraMIMO, ARA, Rural Wireless, TVWS, mMIMO, Skylark Wireless

1 INTRODUCTION

Rural regions of the United States hold significant value to the nation's economy as it is a major source of food and energy for the whole country. About 46 million people live in the rural parts of the US which accounts for 72% of the nation's land. As of today, 39% of the rural regions lack access to broadband Internet [9]. The agricultural practices are advancing rapidly and the demand for network connectivity is ever-increasing. Emerging rural industries depend heavily on high-speed connectivity for competitive and sustainable business operations, and precision agriculture requires network connectivity from ag farms to edge servers and data centers for processing sensing data in real-time. Network roll-out costs are non-negligible, and major broadband market players tend to focus on the urban and densely populated areas that offer higher revenues. This makes broadband access in rural regions unavailable and unaffordable, and the challenge requires out-of-the-box solutions. Laying fiber cables for high-speed data connectivity to every part of the rural regions is infeasible and costly. Thus wireless connectivity to those regions is a promising alternative.

Broadband users tend to spread out in rural regions, thus rural broadband solutions need to cover as large areas at as little cost as possible. In particular, they need to effectively address both the infrastructure cost and spectrum cost. Promising approaches include (1) using lower frequencies to ensure that the wireless signals have a farther reach, (2) leveraging many-antenna MIMO (mMIMO) and beamforming to direct the energy in desired directions to enhance the coverage gains even further, and (3) using the existing unused TVWS spectrum for rural broadband networks.

To enable research and experimentation with these approaches, we design, implement, and deploy the AraMIMO living lab that features state-of-the-art mMIMO systems. More specifically, through collaboration between the ARA PAWR project [2] and Skylark Wireless [17], AraMIMO deploys Skylark Faros V2 Base Station (BS) and User Equipment (UE) as a key component of the ARA rural wireless

living lab [9]. Currently, AraMIMO has deployed one base station and 7 UEs in rural and agriculture settings, with 14 additional UEs to be deployed by September 2023. The deployment provides connectivity to crop and livestock agricultural farms around the City of Ames, Iowa (where Iowa State University resides), and the UE deployment features both fixed locations in farms and City of Ames as well as mobile platforms such as agriculture vehicles and robots, public safety vehicles, and city buses. Three more Skylark base stations and up to 60 additional UEs will be deployed by spring 2024.

AraMIMO represents the first-of-its-kind living lab for TVWS mMIMO research, education, and innovation, and our work makes the following contributions:

- (1) We deploy the first field-deployed and production-grade TVWS, low-UHF mMIMO system that is based on Skylark Faros V2 mMIMO platform. Field measurements have demonstrated promising performance, for instance, showing more than 100 MHz TVWS spectrum available in the AraMIMO living lab, and with Skylark Faros V2 providing long-range connectivity up to 10 km and achieving a single-sector spectral efficiency of 16 b/s/Hz with a 6 MHz TVWS channel and 6 UEs.
- (2) Besides leveraging the production-grade capability of Skylark Faros V2 for wireless applications research (e.g., those in agriculture automation), we develop and open-source mMIMO APIs along with the software architecture that can be leveraged for wireless research experiments, thus enabling both programmability and high performance and allowing for integrated mMIMO and applications research with user-friendly experimentation workflow and remote access support.
- (3) To characterize the potential of TVWS mMIMO for rural connectivity, we conduct extensive measurement studies in AraMIMO. Our findings provide first-of-its-kind insight into rural mMIMO channel and systems behavior in real-world settings of crop and livestock farms as well as rural cities. We will publicly share our measurement software and data to empower the broad community to build on our work in this study.

The rest of the paper is organized as follows: Section 2 discusses related work. Section 3 provides an overview of AraMIMO. The software architecture and APIs are presented in Section 4 along with experiment workflows and capabilities. Measurement results are presented in Section 5, and Section 6 concludes the paper with a brief future roadmap.

2 RELATED WORK

The idea of using low-UHF frequencies for rural broadband has been under discussion for many years now with FCC

having set up regulations for the use of the TV spectrum [7]. Standards such as IEEE 802.11af [8] has specified spectrum sharing between unlicensed TVWS network devices and licensed TV services in this band. Many recent studies [10, 12] explores potential challenges associated with rural broadband. Sander-Frigau et al. [13] have conducted a comprehensive measurement study of TVWS channels in crop farms. As a proof-of-concept, Skylark Wireless has tested a successful link of up to 29.5 km using 28 antennas operating at a frequency of 707 MHz with 4.5 MHz bandwidth and a UE antenna height of 43 ft [15].

There are several testbeds for mMIMO experimental studies, one of which is POWDER-RENEW [4] in Salt Lake City. POWDER-RENEW features FAROS v1, which is an older version of the Skylark Wireless mMIMO infrastructure having 64 antennas BS operating at the CBRS frequencies. The RENEW project [6] at Rice University features Argos [14] and Agora [5] platforms for mMIMO experimental studies. ArgosNet architecture builds the foundation for the Faros v1 platform and the current Faros v2 system inherits basic building blocks from Argos architecture. Agora is an all-software system that runs mMIMO baseband processing on a general-purpose CPU instead of costly FPGAs.

In comparison to POWDER-RENEW, AraMIMO has UEs spread out in geographical locations providing diverse rural channel conditions for experimental studies. In addition, AraMIMO features the newer version of Skylark Wireless mMIMO infrastructure, i.e., Faros v2, having CU-DU-RU functional split and will be fully compliant with O-RAN standards in the near future. The key strengths of AraMIMO as compared to other mMIMO testbeds are its rural- and agriculture-focused deployment, frequency of operation, and O-RAN-based architecture. On top of all these, AraMIMO is programmable, and we have released the APIs and their software implementation as open source to help users control the system as per their experiment requirements.

3 ARAMIMO SYSTEM DESIGN AND DEPLOYMENT ARCHITECTURE

In what follows, we first discuss the ARA wireless living lab and its AraMIMO component, then we present the Skylark Wireless Faros V2 system platform and the AraMIMO network design and deployment architecture.

3.1 AraMIMO in ARA PAWR

As a part of the NSF PAWR program, ARA [9] wireless living lab serves as a unique platform for advanced wireless research, education, and innovation, with a special focus on the needs and opportunities of rural broadband. More specifically, ARA deploys advanced wireless as well as edge and cloud equipment across the Iowa State University (ISU)

campus, City of Ames (where ISU resides), and surrounding research and producer farms as well as rural communities in central Iowa, spanning a rural area with diameter up to ~60 km (i.e., ~37.5 miles). As shown in Figure 1, the ag farms and communities will be interconnected through the *Ara-Haul*, a multi-modal, long-distance, and high-throughput wireless backhaul infrastructure spanning six rural cities. Within the ag farms and rural cities, the *AraRAN* wireless access infrastructure will be deployed to provide high-capacity, low-latency connectivity to User Equipment (UE) such as ag ground vehicles and robots, phenotyping cameras and sensors, police cars, school buses, and students' laptops. Some farms and communities are also interconnected with *fiber networks*, which facilitate ARA management and enable experiments involving both fiber and wireless networks. AraRAN features three types of RAN networks, (1) NI SDRs using OAI and srsRAN protocol stacks, (2) Ericsson 5G, and (3) AraMIMO with Skylark Faros V2. NI SDRs use the mid-band frequencies around 3.5 GHz, targeting programmable wireless experiments. Ericsson network uses the n78 band (3.450–3.550, GHz) and n261 mmWave frequency band (27.5–28.35 GHz), targeting rural town applications experiments and COTS equipment-based wireless experiments. AraMIMO uses the low-UHF band from 470 MHz to 700 MHz, targeting wireless and applications experiments for sparsely populated areas around rural towns (e.g., ag farms).

The AraMIMO deployment currently operates at 563 MHz, and it supports 40 MHz bandwidth. The band 563 MHz has been chosen based on field measurements to study the availability of unused TVWS channels. We used the Keysight Fieldfox spectrum analyzer to check occupied bands in the coverage area of the ARA deployment. This study helped identify the right selection of filters for manufacturing the Skylark radios. The current RX filters on the radios allow frequencies from 540 MHz to 593 MHz, however, the filters can be bypassed via software APIs to enable the whole TVWS

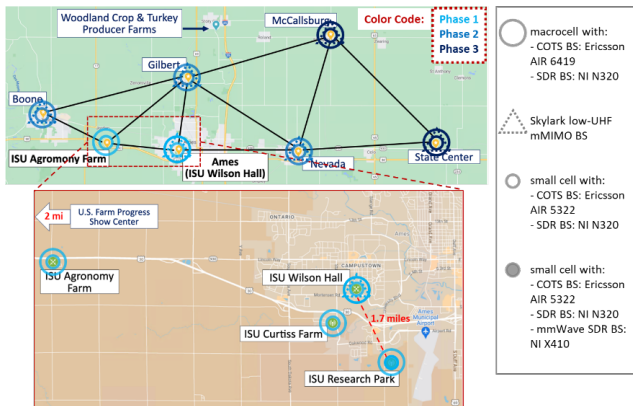

Figure 1: ARA PAWR Deployment

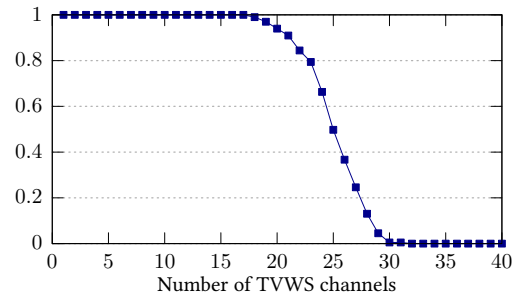

Figure 2: CCDF of Available TVWS Channels in AraMIMO

band from 470 MHz to 700 MHz. There are three RX filters on the radios:

- (1) **UHF Low** with a bandwidth of 24 MHz from 538 MHz to 562 MHz.
- (2) **UHF High** with a bandwidth of 30 MHz from 563 MHz to 593 MHz.
- (3) **Broadband** ranging from 460 MHz to 776 MHz covering the whole TVWS band.

These filters are software selectable and any of them can be used depending on the frequency used for communications.

To understand the availability of TVWS spectrum, we measure channel occupancy around the City of Ames using Keysight RF Sensors. The result is presented in Figure 2 which is a complementary Cumulative Distribution Function (CCDF) of available channels. We see that at least 17 TV channels are available 100% of the time accounting for 102 MHz of bandwidth that can be utilized for rural broadband communications.

3.2 Skylark Faros V2 Platform

The Skylark Wireless BS follows the O-RAN type architecture which disaggregates the RAN functions into Central Unit (CU), Distributed Unit (DU), and Radio Unit (RU). Using the second generation system of Skylark Wireless called Faros V2, AraMIMO supports low-UHF mMIMO-focused RAN experiments. It is pertinent to mention that Faros V2 is not fully O-RAN compliant yet and is under development to fully comply with the O-RAN standards. However, it does provide a basis for O-RAN infrastructure (especially on the RF aspects such as wireless channels), and newly developed O-RAN compliant implementations will be integrated into AraMIMO in the near future. The detailed design of Faros V2 is as follows.

- (1) **Faros CU** is an Intel-based CPU running Ubuntu 20.04 with a dedicated FPGA network interface card to accelerate the PHY application. The CU runs the main services responsible for executing the PHY and MAC. The FPGA card has four SFP+ interfaces, one of which

is for uplink while three interfaces are for downlink that can connect to three DUs.

- (2) **Faros DU** has an FPGA module responsible for clocking and synchronization of the Radios on the RUs. Each DU can connect up to six RUs. The DU also has a reference radio that is used for communicating pilots to and from the radios on the RUs for reciprocity calibration and monitoring. The Channel State Information (CSI) from these pilots along with the uplink pilots from UEs is used in estimating the downlink channel. The reference radio has two channels and is connected to two omnidirectional antennas.
- (3) **Faros RU** consist of 7 radio modules, each having two radio channels. Each radio is connected to one polarization of a dual-polarized antenna resulting in a total of 14 antenna ports. Each RU connects to a power distribution unit (PDU) for powering up the radios and to a fiber distribution unit (FDU) that connects it to the DU.
- (4) **Faros UE** is the client radio that connects to the Faros BS. The UE radio also has two channels and connects to a directional dual-polarized antenna at fixed locations and two omnidirectional antennas at mobile locations. The UE is powered through a 1 Gbps power-over-Ethernet (PoE) port on the UE.

The BS is deployed on the rooftop of the Wilson residence hall, Iowa State University. The CU is inside the cabinet on the rooftop while the DU is mounted outside the cabinet on a metal platform. There are a total of 3 RUs covering 3 sectors of 120° . Since each RU has 14 antenna elements, the total number of antennas are 42. The Skylark Wireless system is modular and can be easily expanded to support a total of 12 RUs having a total of 168 antenna elements. This means that each sector can have 4 RUs and 56 antenna elements. The deployment on the rooftop of Wilson Hall is shown in Figures 3(a) and (b). Figures 3(c) and (d) shows the UE deployed in the field.

3.3 Deployment Architecture

Figure 4 shows the deployment architecture of AraMIMO. The Skylark CU uplink is connected to a Juniper ACX710 router which acts as a gateway for the uplink traffic from the CU. This interface on the router is configured with subinterfaces, each with a different VLAN for each UE connected to the BS. The link from the CU to the UE is in Layer-2 mode with a dedicated VLAN for each UE. On the UE side, we have deployed a switch that acts as a PoE source to power up the UE. The switch is connected to other equipment on the UE such as management and host computers and cameras. The host computer on the UE gets an IP address from the ACX710 router on the BS via the Skylark wireless link.

4 ARAMIMO SOFTWARE ARCHITECTURE AND API DESIGN

Here we present the Skylark Faros V2 software system and the corresponding APIs developed for experimentation in AraMIMO.

4.1 Skylark Faros V2 Software System

The Skylark Wireless Faros V2 system runs its software protocol stack of several services that interact with one another to support mMIMO operations. There are three primary services that run on the CU.

- (1) A service responsible for running the PHY and MAC layer protocols.
- (2) A service to manage (e.g., configure and monitor) the mMIMO system.
- (3) A service that controls the messaging between different services and threads.

The implementation of these services is hidden from users just like other commercial systems, but it exposes APIs that can be leveraged to change, control, and configure individual services for supporting experimental studies.

4.2 Modding APIs for mMIMO Implementations

The term *modding* refers to modifying parts of software that were not initially intended by the developer. On the Faros V2 system, several modules have been exposed via modding APIs to make the platform programmable so that the default mMIMO implementation can be changed for experimental studies, for instance, changing mMIMO beamforming and scheduling algorithms. Figure 5 shows key Faros V2 beamforming modules on the left and the Modding modules on the right. The modules are defined in the Faros V2 software, and their implementation is hidden from users. The modding modules are user-defined and here we provide a reference design that serves as an example to demonstrate how the modding APIs can be used to write the user's own modules bypassing the default Faros V2 modules.

The Faros V2 modules work as follows:

- The UE sends uplink pilots that are received at each of the BS antennas. The CSI data obtained from the pilots are fed into the CSI Collection module.
- Orthogonality between user channels is calculated from the CSI.
- Users are grouped based on the calculated orthogonality values.
- Downlink weights are calculated for each group to schedule the data for downlink transmission.
- An optimal Modulation and Coding Scheme (MCS) is chosen for the transmission.

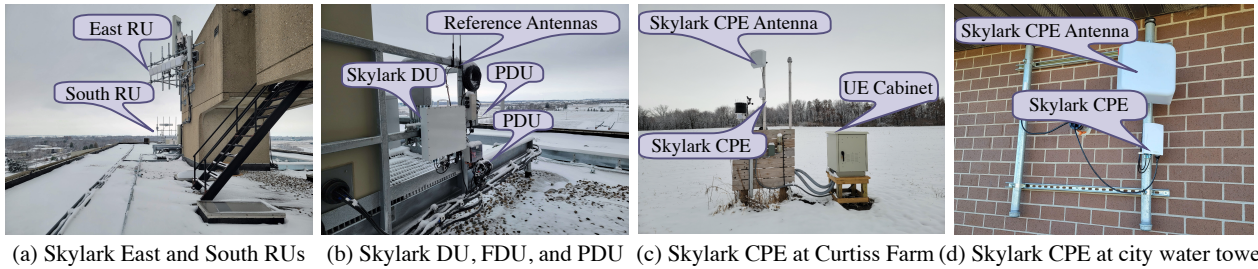

Figure 3: Field Deployment of Skylark Faros V2 System

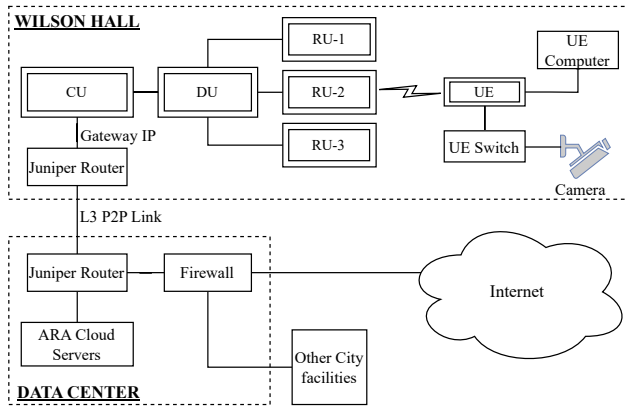

Figure 4: Skylark Deployment Architecture

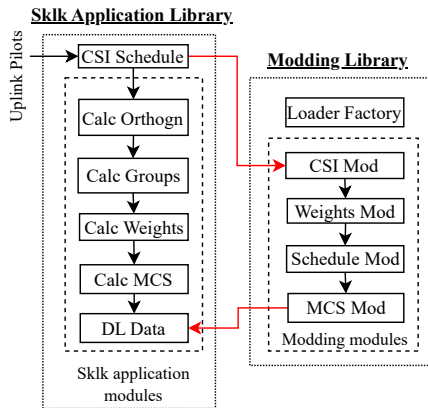

Figure 5: Modding API Architecture

- The downlink data is sent over the air through the BS antennas.

When modding APIs are enabled, the CSI data is sent directly to the user-defined modding library where it can arrange the CSI in its own format, calculate the weights, form groups, and schedule the downlink data based on the user-defined scheduling algorithm. This makes the architecture modular and flexible where users can write their own scheduling and grouping algorithms for experimental

studies on actual field-deployed hardware. We have released the modding APIs and the reference design as open-source on GitHub [16], to support experimental studies by other AraMIMO users.

4.3 Management APIs for mMIMO Operations

The Faros V2 software runs a dedicated service for managing (e.g., configuring and monitoring) the mMIMO system. It has a Command Line Interface (CLI) for configuring system parameters and monitoring communications performance. While the system CLI cannot be directly exposed to users to ensure system integrity, we have developed a wrapper management API that makes API calls to the Remote Procedure Calls (RPC) methods in the Faros V2 management service to configure and monitor the system. AraMIMO exposes a subset of the APIs to users for experimental studies. This will help users in writing scripts to automate their AraMIMO experiments. We have also released example scripts as open source on GitLab [3] and provided related documentation in the ARA User Manual [1] to help users define their own experiments and write their automation scripts. The API calls workflow is shown in Figure 6.

The ARA PAWR software platform is developed by extending OpenStack and chi-in-a-box [11] to manage resources such as AraMIMO. The workflow for a typical AraMIMO management experiment is presented as follows and is documented in detail in the ARA User manual [1].

- (1) A user logs into the ARA Portal remotely and creates a reservation on the compute host.
- (2) The user launches a pre-built container which has the required packages installed along with the AraMIMO management APIs.
- (3) The user launches the provided CLI in the container that leverages the management APIs to configure and monitor the network.
- (4) The user can use the example scripts provided in the container and can also write custom scripts to run experiments.

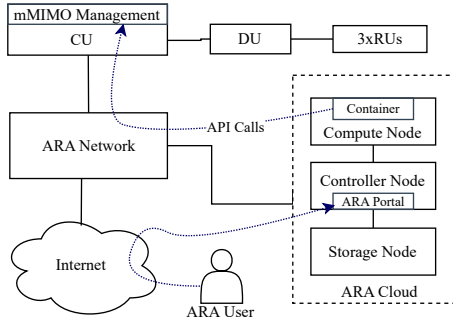

Figure 6: Management API Architecture

5 MEASUREMENT STUDY

We now present measurement results with a focus on weather impact, system capacity, and MU-MIMO analysis. All the data have been collected through the AraMIMO wrapper APIs, and the measurement software has been released as open-source on GitLab [3] to enable other AraMIMO users to build on this study. Our measurement study uses six UEs in the south sector of the BS. The deployment of these UEs can be seen in Figure 7 along with the distances from BS and antenna heights. Other parameters are tabulated in Table 1. All the UEs have the same transmit and receive gain settings. The center frequency is chosen based on the availability of the particular TV channel during the period of the study. Similarly, the max bandwidth of 24 MHz is chosen based on the spectrum availability around the center frequency.

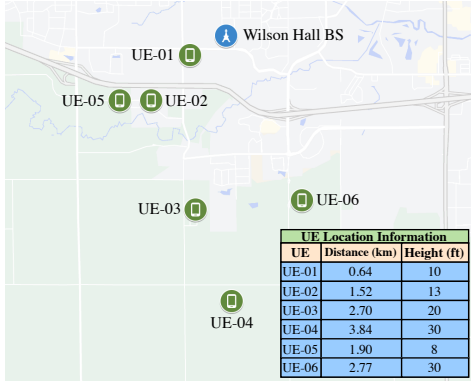

Figure 7: Skylark BS and UE Deployment in Ames, Iowa

5.1 Weather Impact

The Faros V2 system allows us to capture real-time CSI data over the air. We performed experiments to record such data in real-time and analyzed Low-UHF mMIMO channel correlations to understand the impact of weather.

Figure 8 shows the impact of weather on rural low-UHF mMIMO channels. We collected raw CSI data before snow,

Table 1: System Configuration Parameters

System Parameters	Values
Frequency	563 MHz
Bandwidth	{6, 12, 18, 24} MHz
BS antenna height	120 ft
UE antenna height	Refer Figure 7
Number of RUs	3
Antennas per RU	14
Transmit Power	30 dBm
Antenna Gain	7.5 dBi
Number of UEs	6
Antennas per UE	2

during snow, before rain and during rain. We used the IQ samples of uplink pilots from the UEs for this analysis. We analyzed the correlation of channels between each antenna pair. We can see that there is a higher degree of correlation between the channels before snow than during snow and before rain than during rain. This shows that the channels become more uncorrelated when it is snowing or raining. The parameter r shows the number of channel pairs whose correlation is greater than 0.5. We observe that the number is higher before snow/rain. The decrease in channel correlation during snow/rain is due to the additional randomness introduced by snow/rain as a result of spatial diversity and randomness in snow-flakes/raindrops. This decrease in channel correlation and increase in channel diversity can allow mMIMO to help compensate for the additional path loss introduced by snow/rain.

The reason for antennas 1 to 14 (RU-01) having no correlation with other antennas (RU-02 and RU-03) is that these uplink pilots are from UE-02 in Figure 7 which is towards the

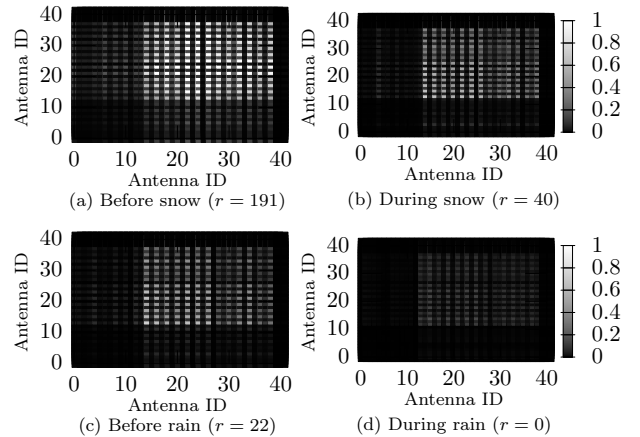

Figure 8: Impact of Snow and Rain on Low-UHF mMIMO Channel Correlation

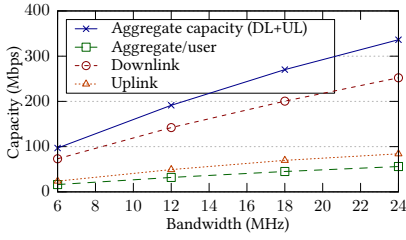

Figure 9: Capacity for 6 UEs

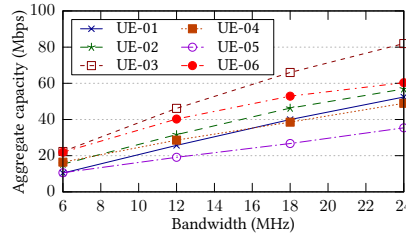

Figure 10: Capacity per UE

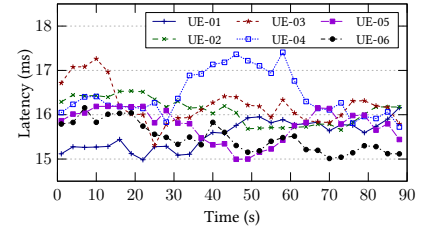

Figure 11: Latency from BS to UEs

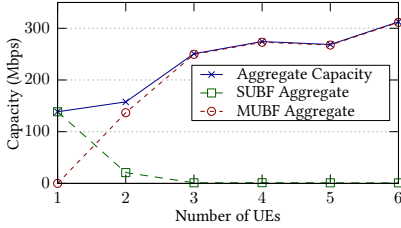

Figure 12: Impact of Number of UEs on System Capacity

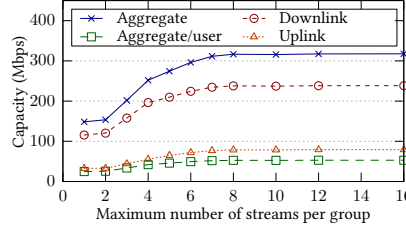

Figure 13: Impact of Maximum Number of Streams on System Capacity

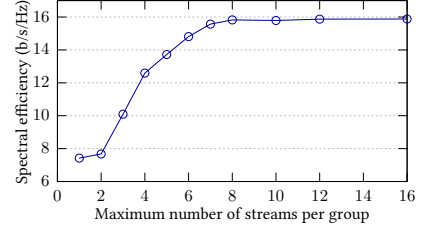

Figure 14: Impact of Increasing Spatial Streams on Spectral Efficiency

south-west sectors while antennas 1–14 are in the east sector. Thus, the signal strength of those pilots is much lower at the east sector, and the correlation coefficients are close to zero.

5.2 System Capacity

To understand the achievable communication capacity of AraMIMO, we measure the capacity and spectral efficiency using the six UEs in the coverage area of the south sector. UE-01 to UE-04 are fixed locations deployed in crop and livestock farms. UE-05 and UE-06 are portable UEs that were deployed in the south sector for this study. The BS has demonstrated a communication capacity of 350 Mbps with 24MHz bandwidth (equivalent of 4 TVWS channels) in the field with six UEs in the south sector of the BS. Figure 9 shows the downlink (DL), uplink (UL) and aggregate (i.e., DL + UL) capacity of the system with increasing channel bandwidth.

The figure also shows that a single TVWS channel of 6 MHz can achieve up to 100 Mbps of aggregate capacity in one sector (14 antennas). Having UEs in the other sectors will push this capacity even further since the RUs are each covering 120 degrees sectors. The average aggregate capacity per user is also shown, which is about 50 Mbps at 24 MHz bandwidth.

Figure 10 shows the aggregate capacity (UL + DL) for each of the six UEs. The maximum capacity is observed for UE-03 while the lowest is for UE-05. From Figure 7, we see that UE-03 is directly in front of the south sector so it has higher capacity. UE-04 is also directly in front of the south sector but has a longer distance so its capacity is lower than that of UE-03. UE-05 has the lowest capacity because it is located toward the edge of the coverage area of the south sector

and away from its main lobes. UE-01 and UE-02 have higher capacity than UE-05 because they are closer to the BS than UE-05.

Figure 11 shows the latency between the BS and UEs. We measure the round trip latency for 2 minutes from the CU to UEs and divide by 2 for latency along the wireless links. We can see that the latency is around 16 ms on average with some variations of ± 1 ms. The values on the plot are calculated as the moving average of the actual values measured.

5.3 MU-MIMO Behavior

To show the impact of MU-MIMO gains, we connect the UEs one by one to the BS (in the order of UE-01, UE-02, UE-03, ...) and measure the system capacity. The BS is configured at a center frequency of 563 MHz and a bandwidth of 20 MHz. Figure 12 shows that the aggregate capacity increase as the number of UEs increases.

An important observation is that the jump in capacity from UE-01 to UE-02 is less than the jump from UE-02 to UE-03. The reason is that UE-01 and UE-02 are in almost the same direction from BS while UE-03 is in a different direction directly facing the south sector. Similar observations can be noticed for UE-04 and UE-05 as well since they are in the same directions and locations as UEs 01, 02, and 03, so there is not much gain in capacity. However, when UE-06 connects, we see some gains as it is at a different location away from all other UEs. Figure 12 also shows that the Single-User Beamforming (SUBF) is equal to the aggregate capacity when only one UE is connected; it quickly dies down to zero as other UEs join, and Multi-User Beamforming (MUBF) dominates.

Next, we show the impact of the number of spatial streams per group on the system capacity and spectral efficiency. For this study, we limit the maximum number of streams per group and record the capacity with all UEs connected. The BS is configured at 563 MHz with a bandwidth of 20 MHz. As the number of concurrent spatial streams allowed per group increases, Figures 13 and 14 show that the aggregate capacity and spectral efficiency (b/s/Hz) increase. The capacity and spectral efficiency increase up to 8 streams allowed per group, and then there is no effect if we further increase the number of maximum streams per group due to the lack of additional spatial diversity. We have a total of 6 UEs with a total of 12 streams together; however, the grouping data show that we have no groups that have streams greater than 8 streams, hence no impact on the system performance beyond 8 streams per group.

6 CONCLUSION

We have developed and deployed AraMIMO in real-world rural settings, a first-of-its-kind TVWS many-antenna MIMO living lab for rural wireless and applications. AraMIMO leverages TVWS and MU-MIMO to deliver high-capacity connectivity over large geographical areas. Through open-source APIs of the production-grade Skylark Faros V2 mMIMO system, AraMIMO offers both programmability and robustly high performance needed for integrated wireless and applications research. Our measurement studies in AraMIMO have demonstrated the promise of TVWS mMIMO in addressing the rural broadband challenge, as well as the capabilities of AraMIMO in serving as a living lab for TVWS mMIMO experimentation. With a significant number of UEs and more base stations to be deployed in the coming year, AraMIMO is expected to provide rich opportunities for experimental studies on mMIMO and rural wireless in general.

ACKNOWLEDGMENT

This work is supported in part by the NIFA award 2021-67021-33775, and NSF awards 2130889, 2112606, 2212573, 2229654, and 2232461. We thank John Bennett George for his contribution and support in ARA deployment, and Mukaram Shahid for his help with TVWS spectrum study. We also thank Ken Scianna, Ryan E. Guerra, and other Skylark Wireless colleagues for their help in AraMIMO deployment and API development.

REFERENCES

- [1] ARA. 2023. ARA User Manual. Retrieved Aug 5, 2023 from <https://arawireless.readthedocs.io/>
- [2] ARA. 2023. ARA Wireless Living Lab. Retrieved Aug 5, 2023 from <https://arawireless.org>
- [3] ARA. 2023. AraMIMO API Wrapper. Retrieved Aug 5, 2023 from <https://gitlab.com/aralab/arasoft/aramimo/aramimo>
- [4] Joe Breen, Andrew Buffmire, Jonathon Duerig, Kevin Dutt, Eric Eide, Mike Hibler, David Johnson, Sneha Kumar Kasera, Earl Lewis, Dustin Maas, Alex Orange, Neal Patwari, Daniel Reading, Robert Ricci, David Schurig, Leigh B. Stoller, Jacobus Van der Merwe, Kirk Webb, and Gary Wong. 2020. POWDER: Platform for Open Wireless Data-Driven Experimental Research. In *Proceedings of the 14th International Workshop on Wireless Network Testbeds, Experimental Evaluation & Characterization* (London, United Kingdom) (WiNTECH'20). Association for Computing Machinery, New York, NY, USA, 17–24. <https://doi.org/10.1145/3411276.3412204>
- [5] Jian Ding, Rahman Doost-Mohammady, Anuj Kalia, and Lin Zhong. 2020. Agora: Real-Time Massive MIMO Baseband Processing in Software. In *Proceedings of the 16th International Conference on Emerging Networking EXperiments and Technologies* (Barcelona, Spain) (CoNEXT '20). Association for Computing Machinery, New York, NY, USA, 232–244. <https://doi.org/10.1145/3386367.3431296>
- [6] Rahman Doost-Mohammady, Lin Zhong, and Ashutosh Sabharwal. 2022. Renew: A Software-Defined Massive MIMO Wireless Experimentation Platform. *GetMobile: Mobile Comp. and Comm.* 26, 2 (jul 2022), 12–18. <https://doi.org/10.1145/3551670.3551674>
- [7] FCC. 2012. Federal Communications Commission. Retrieved Aug 5, 2023 from <https://www.fcc.gov/general/white-space>
- [8] Adriana B. Flores, Ryan E. Guerra, Edward W. Knightly, Peter Ecclesine, and Santosh Pandey. 2013. IEEE 802.11af: a standard for TV white space spectrum sharing. *IEEE Communications Magazine* 51, 10 (2013), 92–100. <https://doi.org/10.1109/MCOM.2013.6619571>
- [9] Hongwei Zhang and Yong Guan and Ahmed Kamal and Daji Qiao and Mai Zheng and Anish Arora and Ozdal Boyraz et al. 2022. ARA: A wireless living lab vision for smart and connected rural communities. In *Proceedings of the 15th ACM Workshop on Wireless Network Testbeds, Experimental evaluation & Characterization*. Association for Computing Machinery, New York, NY, USA, 9–16.
- [10] Md Zobaer Islam, John F. O'Hara, Dylan Shadoan, Mostafa Ibrahim, and Sabit Ekin. 2021. TV White Space Based Wireless Broadband Internet Connectivity: A Case Study With Implementation Details and Performance Analysis. *IEEE Open Journal of the Communications Society* 2 (2021), 2449–2462. <https://doi.org/10.1109/OJCOMS.2021.3123939>
- [11] K Keahey, J Anderson, HS Gunawi, J Mambretti, P Ruth, and D Stanzione. 2020. Chameleon cloud. *Web Page, Dec* (2020).
- [12] Mahbubur Rahman and Abusayeed Saifullah. 2019. A comprehensive survey on networking over TV white spaces. *Pervasive and Mobile Computing* 59 (2019), 101072. <https://doi.org/10.1016/j.pmcj.2019.101072>
- [13] Matthias Sander-Frigau, Tianyi Zhang, Chen-Ye Lim, Hongwei Zhang, Ahmed E. Kamal, Arun K. Somani, Stefan Hey, and Patrick Schnable. 2021. A Measurement Study of TVWS Wireless Channels in Crop Farms. In *IEEE MASS*.
- [14] Clayton Shepard, Rahman Doost-Mohammady, Jian Ding, Ryan E. Guerra, and Lin Zhong. 2018. ArgosNet: A Multi-Cell Many-Antenna MU-MIMO Platform. In *2018 52nd Asilomar Conference on Signals, Systems, and Computers*. 2237–2241. <https://doi.org/10.1109/ACSSC.2018.8645415>
- [15] Skylark. 2020. Massive MIMO for Rural Broadband. Retrieved Aug 5, 2023 from https://github.com/skylarkwireless/documents/blob/main/Skylark_Faros_Whitepaper_2020.pdf
- [16] Skylark. 2023. AraMIMO Modding API. Retrieved Aug 5, 2023 from <https://github.com/skylarkwireless/sklk-phy-mod>
- [17] Skylark. 2023. Skylark Wireless. Retrieved Aug 5, 2023 from <https://skylarkwireless.com/>